

Varenummer: 0102130
 Beskrivelse: Seeger låsering J 165 DIN 472
 Fjederstål

Mål

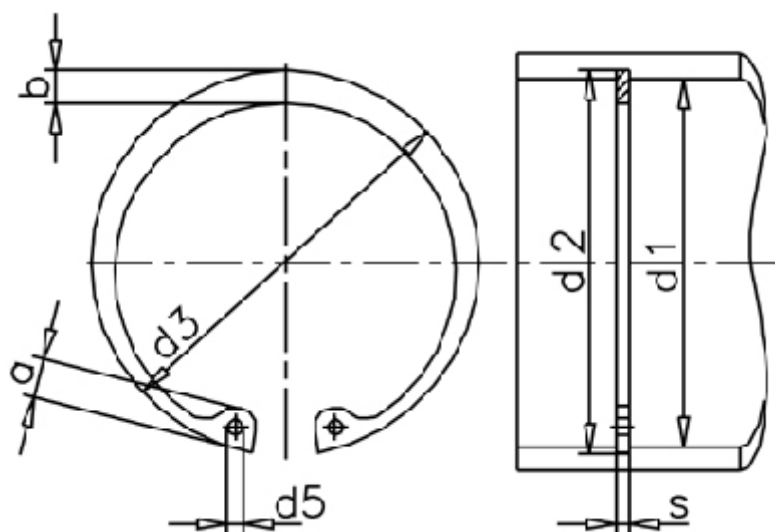

a max	= 13,0	FN kN	= 219.00	t	= 2.50
AN mm ²	= 1315.0	FRg kN	= 54.0	Tang	= ZGJ-5
b	= 11.8	FR kN	= 319.0	tol	= -0.10
Betegnelse	= J 165	g	= 3.5	tol	= +1,50-0,63
d1	= 165	K kN-mm	= 732.0	tol	= +0,63
d2	= 170.0	m min	= 4.15	vægt kg/1000	= 125.00
d3	= 174.50	Nominel træk	= 7.5		
d5 min	= 4.0	s	= 4.00		